



### 300x320 SHI-LR 27x0,9

						
300	0°	45°	60°	45°	60°	$\frac{b}{a \times b}$
320x290	300	300x280	200	270	x	x
			190x200	270x200	x	320x160

				
3x400V 50 Hz	2,4	20-100	3660x27x0,9	650

<b>L</b>	<b>B</b>	<b>Hmin</b>	<b>Hmax</b>	<b>V</b>
2050	1170	1420	2040	800



300x320  
SHI-LR

STANDARD OPTION

300-F

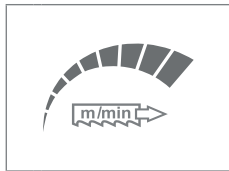

300-PCK

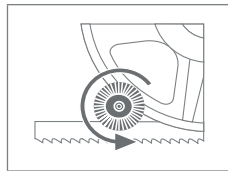

300-DPP

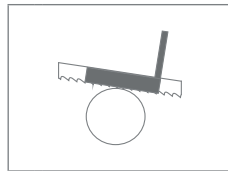

PEGAS-BRP

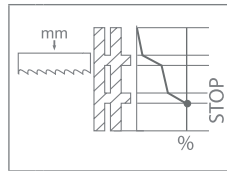

300-RTS

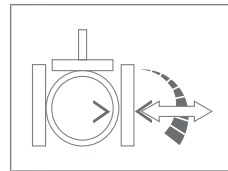

LIGHT L1

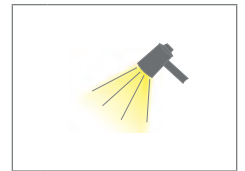

300-PUD

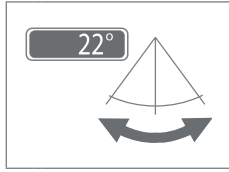

300x320-HP

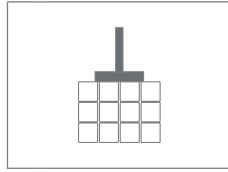

MINI LUBE 27-34

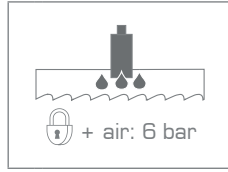

LASER LINE

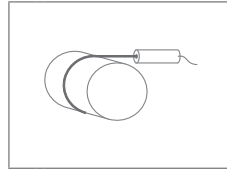

R 390

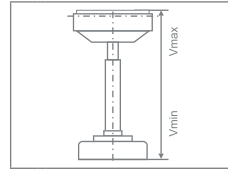

	S (mm)	Vmin (mm)	Vmax (mm)
R	390	760	980

RB 200



RBS 200/390 +RB



RHS 390 +RBS+RB



OZD 1000  
OZD 2000  
OZD 3000  
OZD 4000  
OZD 5000  
OZD 6000

OZ 1000  
OZ 2000  
OZ 3000  
OZ 4000  
OZ 5000  
OZ 6000

OZ 0000



300x320-RDP 1000/350

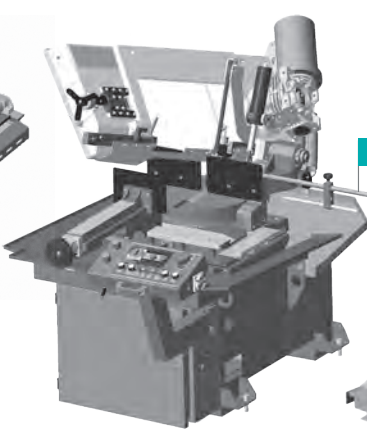
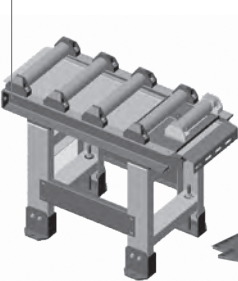

OZM 600



300-SRZ

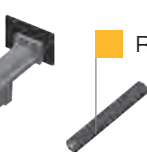

V-350



RD VR-390



300x320-RBS



300x320-RB



300-LR-RDP

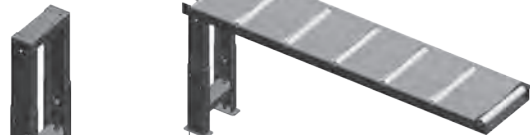

RD 2000/390

RDN

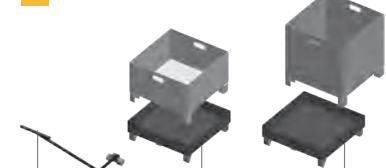

BOX-TAH

BOX-TRI

BOX-PCS

RDT 2000/350



RDT 1000/350



RD 1000/390



CONTROL PANEL: MITSUBISHI

## 300x320 SHI-LR

- výrobce si vyhrazuje právo provádět změny technických údajů, technické údaje odpovídají 1.1.2023 / producer has the right to make changes of technical data, technical data are valid on 1.1.2023

- pila na fotografii není vždy v základním provedení, uvedené rozměry odpovídají stroji v základním provedení / the machine in the picture is not always in the basic version, mentioned diameters are for machine in basic version

\* doporučená hodnota. Při překročení doporučeného maximálního průměru není možné garantovat výkon pilového pásu!

/ recommended value. The blade performance cannot be guaranteed when the recommended diameter is exceeded!

☒ - řezání svazků bez horního přitlačení / cutting of the bundle without top clamping



PEGAS - GONDA s.r.o.  
Čs.armády 322, 684 01 Slavkov u Brna,  
CZECH REPUBLIC

www.pegas-gonda.cz  
00420-544 221 125 (126) | pegas@gonda.cz